

Calculating angles on a straight line

1 Work out the sizes of the unknown angles.

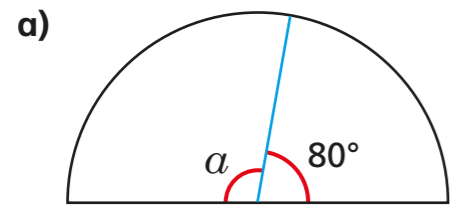

$a = \boxed{100}^\circ$

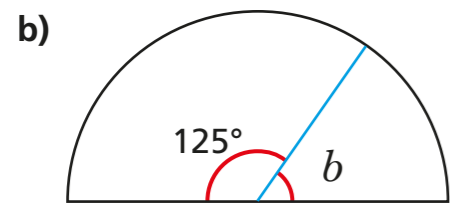

$b = \boxed{55}^\circ$

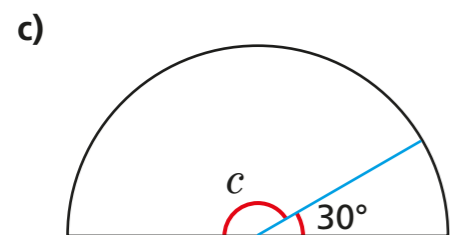

$c = \boxed{150}^\circ$

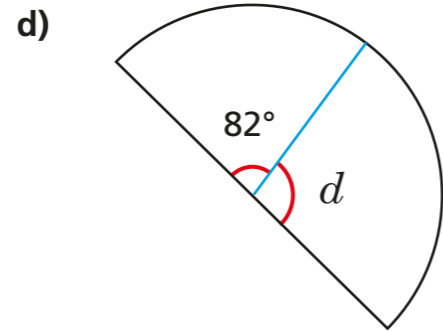

$d = \boxed{98}^\circ$

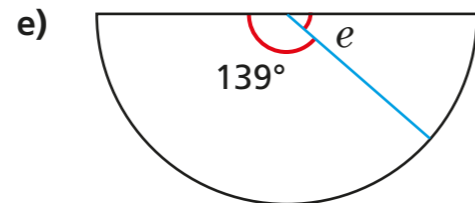

$e = \boxed{41}^\circ$

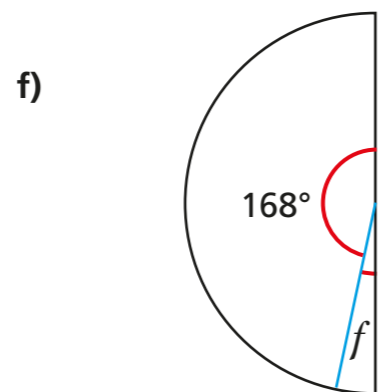

$f = \boxed{12}^\circ$

2 Work out the size of the unknown angles.

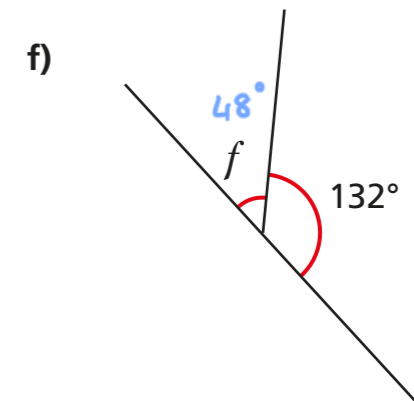
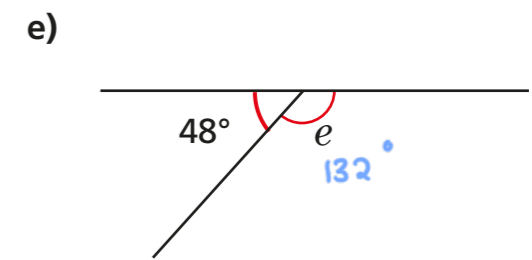
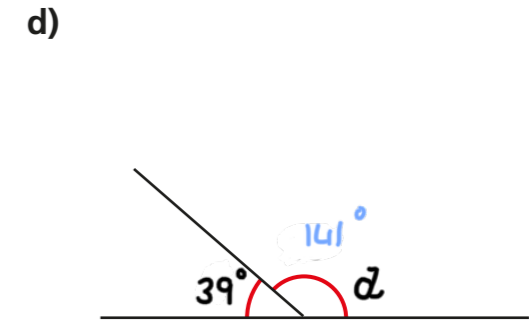
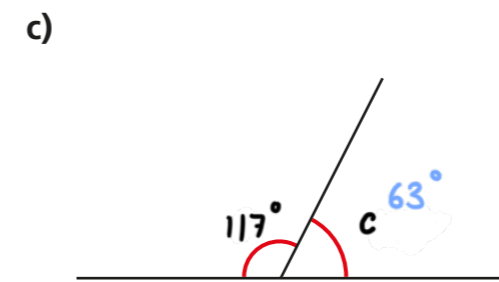
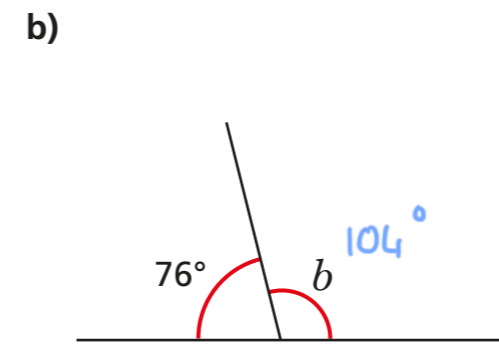
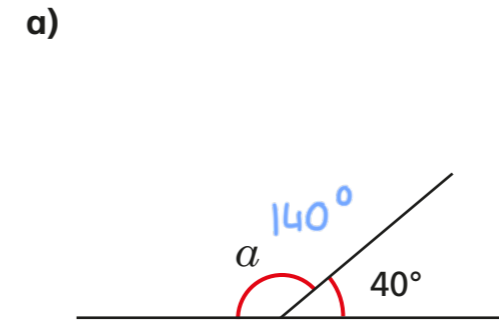

3 Dora draws two angles.

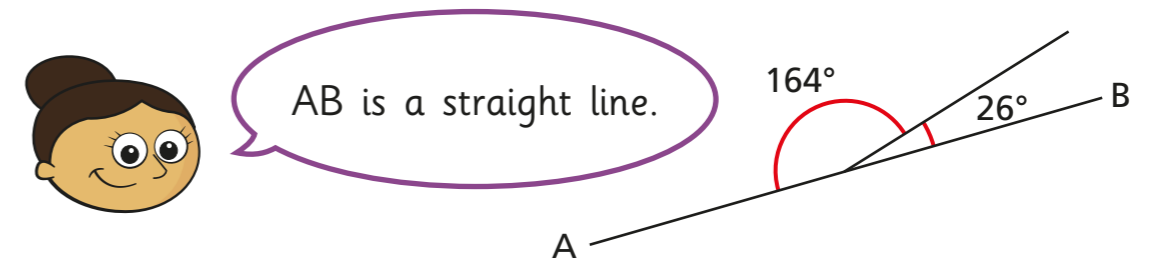

Do you agree with Dora? No

Explain your answer.

4 Work out the size of the unknown angles.

Show the steps in your working.

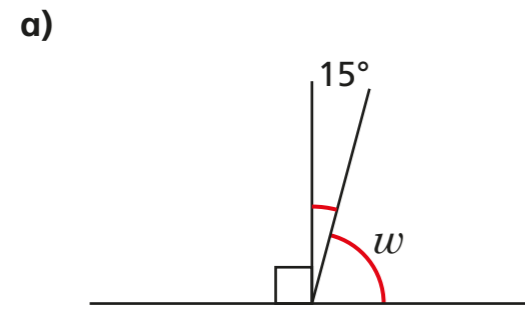

$$w = \boxed{75}^\circ$$

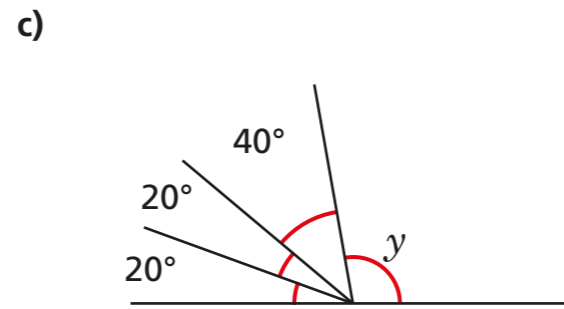

$$y = \boxed{100}^\circ$$

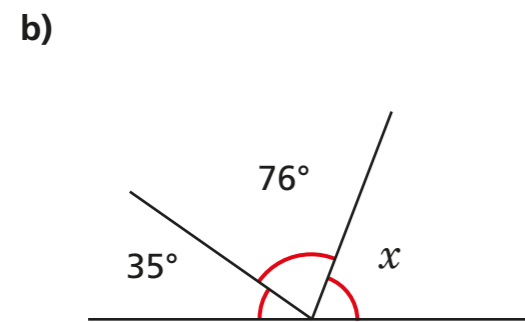

$$x = \boxed{69}^\circ$$

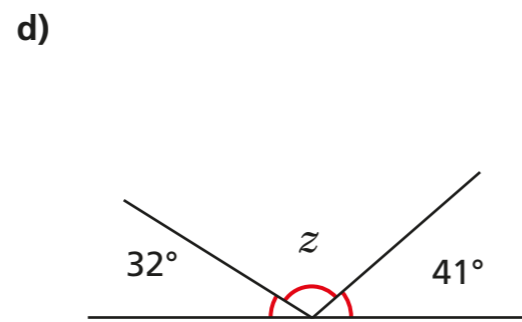

$$z = \boxed{107}^\circ$$

5 Work out the sizes of the unknown angles.

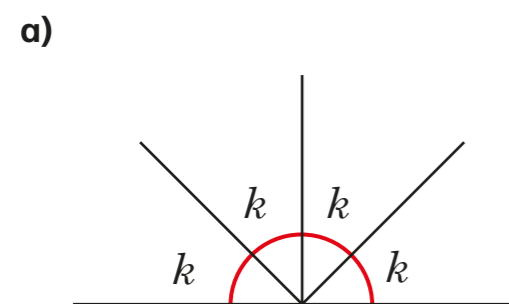

$$k = \boxed{45}^\circ$$

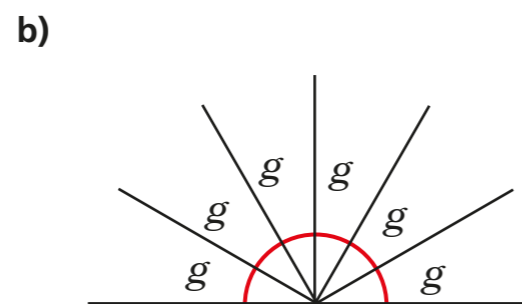

$$g = \boxed{30}^\circ$$

6 Work out the size of angle a .

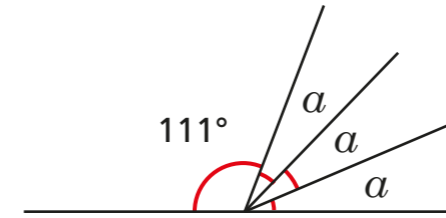

$$a = \boxed{23}^\circ$$

7 Work out the size of angle m .
Show all your working out.

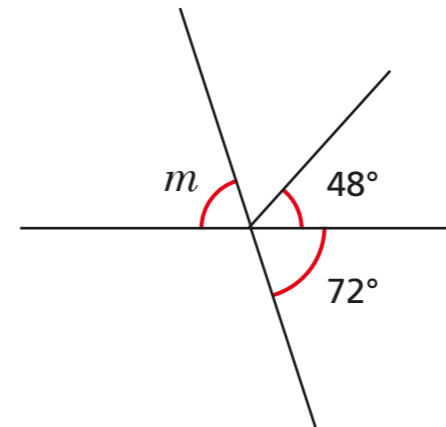

$$m = \boxed{72}^\circ$$

8 Two angles are marked.

Angle b is eight times the size of angle a .
What is the size of each angle?

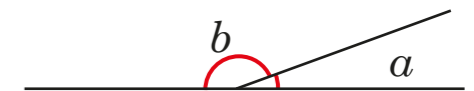

$$a = \boxed{20}^\circ \quad b = \boxed{160}^\circ$$